

# BNC 系列射频同轴连接器

## 概述

BNC 系列产品是按照美军标 MIL-C-39012 研制生产的一种卡口式射频同轴连接器。可与国际同系列产品互换。具有连接迅速、接触可靠等特点，广泛应用于无线电设备和电子仪器中连接射频同轴电缆。

## 主要技术特性

工作温度	-65 ~ +125℃	相对湿度	40 ± 2℃ 时, 90 ~ 95%	
大气压力	101.3kPa ~ 4.4kPa	绝缘电阻(标准条件)	≥ 5000MΩ	
特性阻抗	50Ω	介质耐压(标准条件)	1500Vmax	
振动	10 ~ 2000Hz, 200 m/s <sup>2</sup>	接触电阻	内导体	≤ 0.004Ω
冲击	490 m/s <sup>2</sup>		外导体	≤ 0.0025Ω
使用频率	DC ~ 4GHz	射频泄漏(1~3GHz)		≤ -90dB
电压驻波比	直式	≤ 1.3	插入损耗	0.5dB
	弯式	≤ 1.5	机械寿命	500 次

注: 1. 表中 f 为使用频率, 单位 GHz。  
2. 半刚性电缆连接器工作温度为 -55 ~ +105℃; 灌胶类产品工作温度为 -55 ~ +125℃。

## 执行标准

质量等级	规范代号	适用产品类型
企军标	Q/Jc20140-2008	BNC 接电缆及接微带连接器
企军标	Q/Jc20335-2012	BNC 系列内转接器
七专	Q/Jc20454-2014	接电缆连接器
七专	Q/Jc20455-2014	接微带连接器
七专	Q/Jc20456-2014	转接器
可靠性	LMS070400005-2013	BNC 接微带连接器
可靠性	LMS070400006-2013	BNC 接电缆连接器
可靠性	LMS070400019-2013	转接器

## 头部配合尺寸

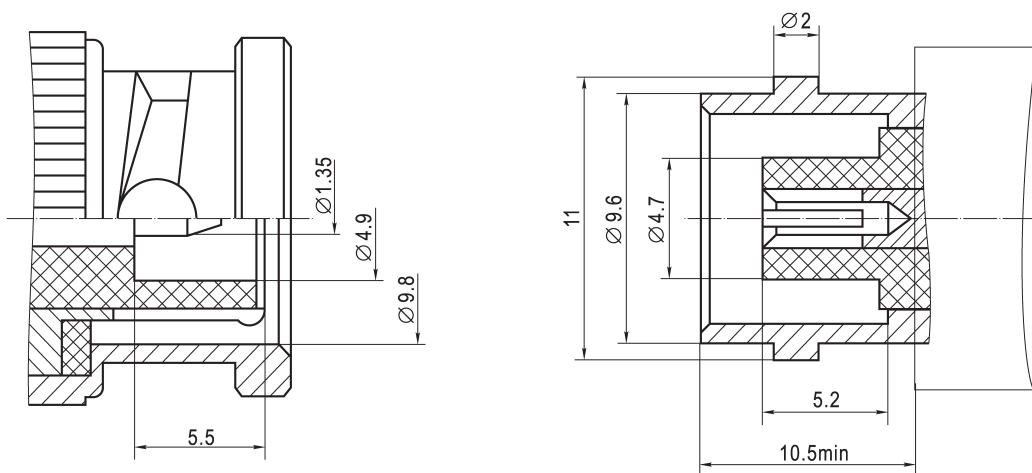

## BNC 系列—电缆插头：自由端、直式

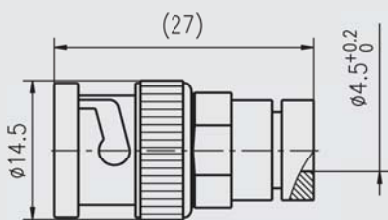

电缆剥线尺寸

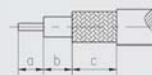

型号	a	b	c	配接电缆型号
BNC-J2	5.8	1.5	4.5	SFF-50-1
BNC-J3-1	5.8	1.5	4.5	STYV-2

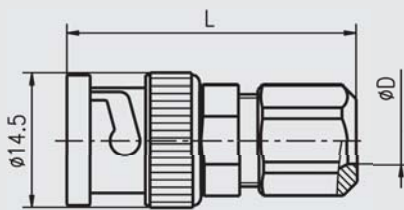

电缆剥线尺寸

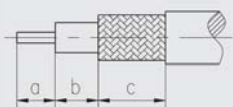

型号	D	L	a	b	c	配接电缆型号
BNC-J3	3.1	31.1	5.5	0.7	8.3	SFF-50-1.5-1
BNC-J4	4.2	31.1	5.5	0.7	7	SFF-50-2-2
BNC-J5	5.2	31.1	5.5	0.7	7	SYV-50-3
BNC-J12	5.2	35	7	1	8	SYV-75-3
BNC-J62	6.3	31	5.7	0.7	7	RG-62/U
BNC-J13	7.4	35	7	1	8	SYV-75-5-1
BNC-J13-1	7.4	31	5.7	0.7	7	RG-62/U
BNC-75J32	3.1	35	2.7	0.7	9.3	SYV-75-2-1

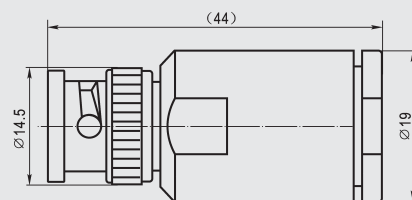

电缆剥线尺寸

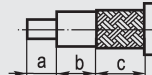

型号	a	b	c	配接电缆型号
BNC-J8	3.5	0	12	SYV-50-7-2

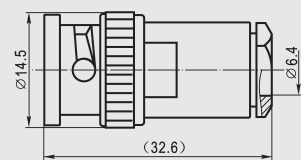

型号	配接电缆型号
BNC-J21	SDY-4

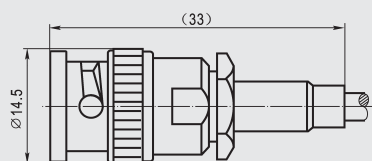

电缆剥线尺寸

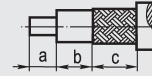

型号	a	b	c	配接电缆型号
BNC-J2Y	2.5	10.5	3.5	SFF-50-1
BNC-J3Y	2.5	10.5	3.5	SFF-50-1.5-1
BNC-J12Y	3.5	9.5	10	SFF-50-1

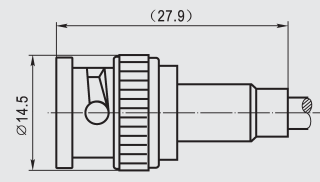

电缆剥线尺寸

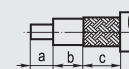

型号	a	b	c	配接电缆型号
BNC-J4Y	3.8	4	9.5	SFF-50-2-2
BNC-J5Y	3.8	4	9.5	SYV-50-3

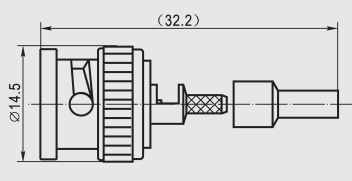

电缆剥线尺寸

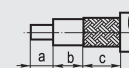

型号	a	b	c	配接电缆型号
BNC-75J3YA	2.3	2.2	5.4	SFYZ-75-2-1

BNC 系列—电缆插头：自由端、弯式

BNC

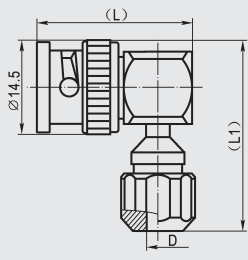

电缆剥线尺寸

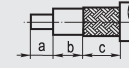

型号	D	L	L1	a	b	c	配接电缆型号
BNC-JW3	Φ3.1	26	27.4	3.4	8.4	2	SFF-50-1-1
BNC-JW4	Φ4.2	26	27.4	3.4	8.4	2	SFF-50-2-2
BNC-JW5	Φ5.2	26	27.4	3.4	8.4	2	SYV-50-3
BNC-JW12	Φ5.2	28	35	3.4	8.4	2	SYV-75-3

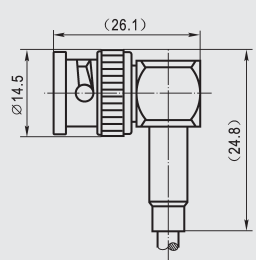

电缆剥线尺寸

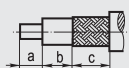

型号	a	b	c	配接电缆型号
BNC-JW3Y	3.4	2.9	9.5	SFF-50-1.5-1
BNC-JW4Y	3.4	2.9	9.5	SFF-50-2-2
BNC-JW5Y	3.4	2.9	9.5	SYV-50-3

BNC 系列—电缆插座：四孔法兰盘安装、直式

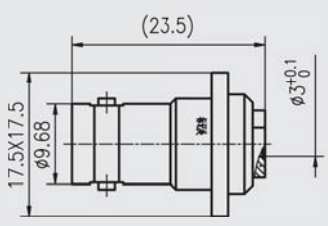

电缆剥线尺寸

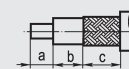

型号	a	b	c	配接电缆型号
BNC-KF3	2.5	2.4	2.3	SFF-50-1.5-1

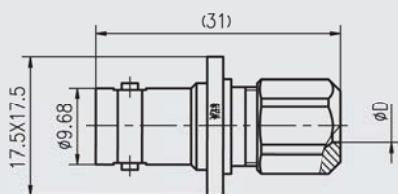

电缆剥线尺寸

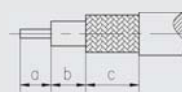

型号	D	a	b	c	配接电缆
BNC-KF4	Φ4.2	5.1	0.7	7	SFF-50-2-2
BNC-KF5	Φ5.2	5.1	0.7	7	SYV-50-3
BNC-KF12	Φ5.2	7	8	8	SYV-75-3
BNC-KF13	Φ7.4	7	8	8	SFF-75-5-1

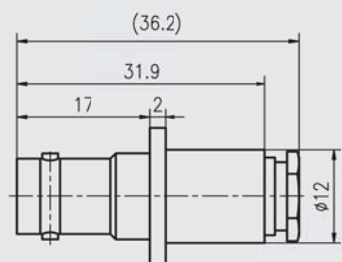
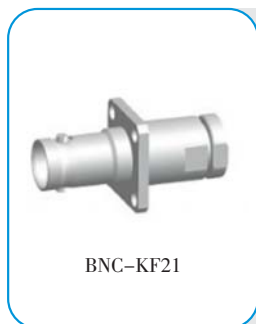

安装开孔尺寸

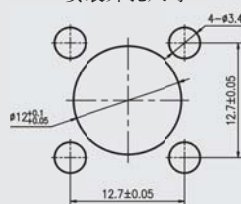

电缆剥线尺寸

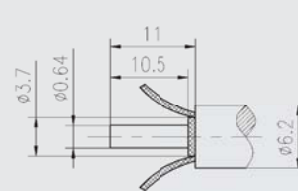

配接电缆:SDY-4或其他相同尺寸规格电缆

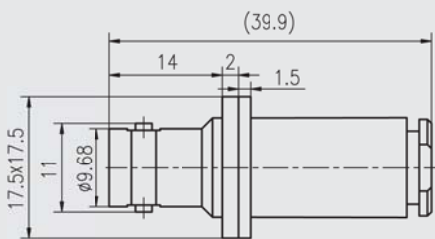
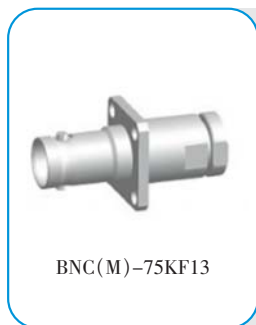

安装开孔尺寸

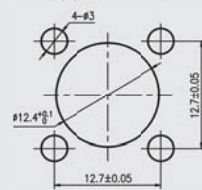

电缆剥线尺寸

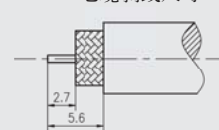

配接电缆:SYV-75-5-1或SYV-75-5-2

**BNC 系列—电缆插头：螺母安装、直式**

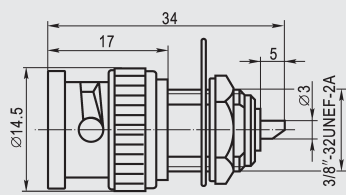
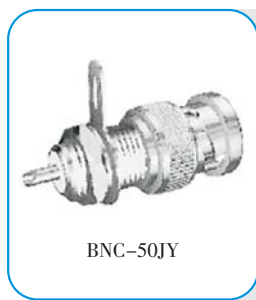

安装开孔尺寸

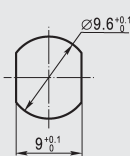

**BNC 系列—电缆插座：螺母安装、直式**

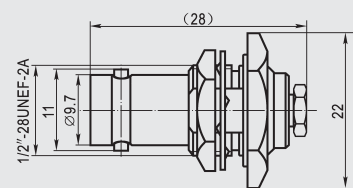

安装开孔尺寸

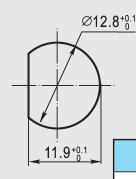

电缆剥线尺寸

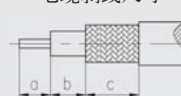

型号	a	b	c	配接电缆型号
BNC-KY2	2.5	10.5	5.3	SFF-50-1 SYV-50-1

BNC



BNC-KY3

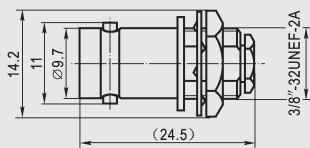

安装开孔尺寸

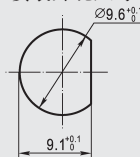

电缆剥线尺寸

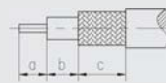

型号	a	b	c	配接电缆型号
BNC-KY3	2.4	3.8	0.8	SFF-50-1.5-1 SYV-50-2-1



BNC(S)-KY3

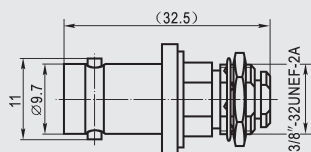

安装开孔尺寸

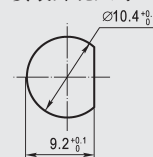

电缆剥线尺寸

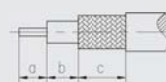

型号	a	b	c	配接电缆型号
BNC(S)-KY3	4.2	0	6	SFF-50-1.5-1 SYV-50-2-1



BNC-KY4等

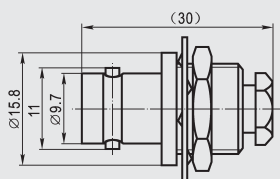

安装开孔尺寸

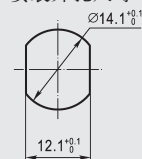

电缆剥线尺寸

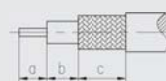

型号	a	b	c	配接电缆型号
BNC-KY4	4.6	0.7	7	SFF-50-2-2 SYV-50-2-2
BNC-KY5	4.6	0.7	7	SFF-50-3-1 SYV-50-3



BNC-KY21

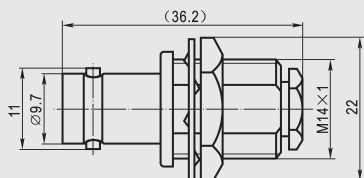

安装开孔尺寸

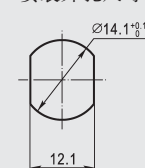

型号	配接电缆型号
BNC-KY21	SDY-4



BNC-KY2Y等

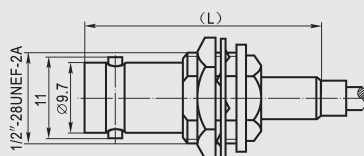

安装开孔尺寸

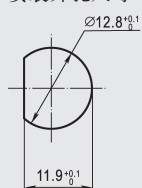

电缆剥线尺寸

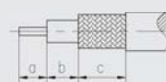

型号	L	a	b	c	配接电缆型号
BNC-KY2Y	30	2.4	11	5.6	SFF-50-1 SYV-50-1
BNC-KY3Y	30	2.4	11	5.6	SFF-50-1.5-1 SYV-50-2-1
BNC-KY4Y	35.5	5.5	5	4.5	SFF-50-2-2 SYV-50-2-2
BNC-KY5Y	35.5	5.5	5	4.5	SYV-50-3

## BNC 系列—微带插座：四孔法兰盘安装、直式



BNC-50KFD

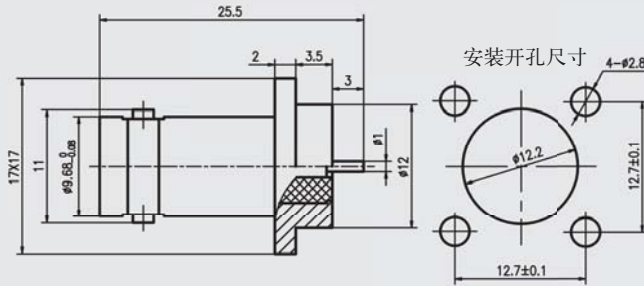

BNC-50KF 等

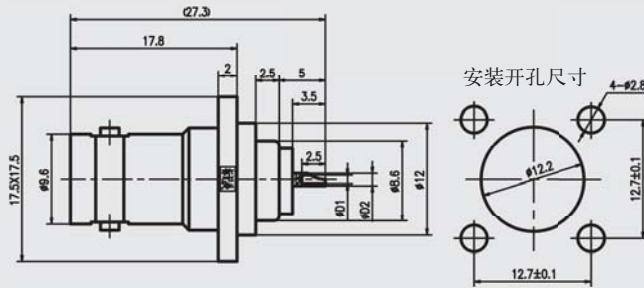

型号	D1	D2
BNC-50KF	1.6	2.14
BNC-75KF	0.9	1.2

## BNC 系列—微带插座：焊接安装、直式



BNC-75KHD2

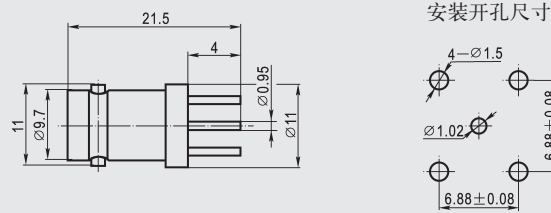

BNC-KWHD11

